

SERIE UP

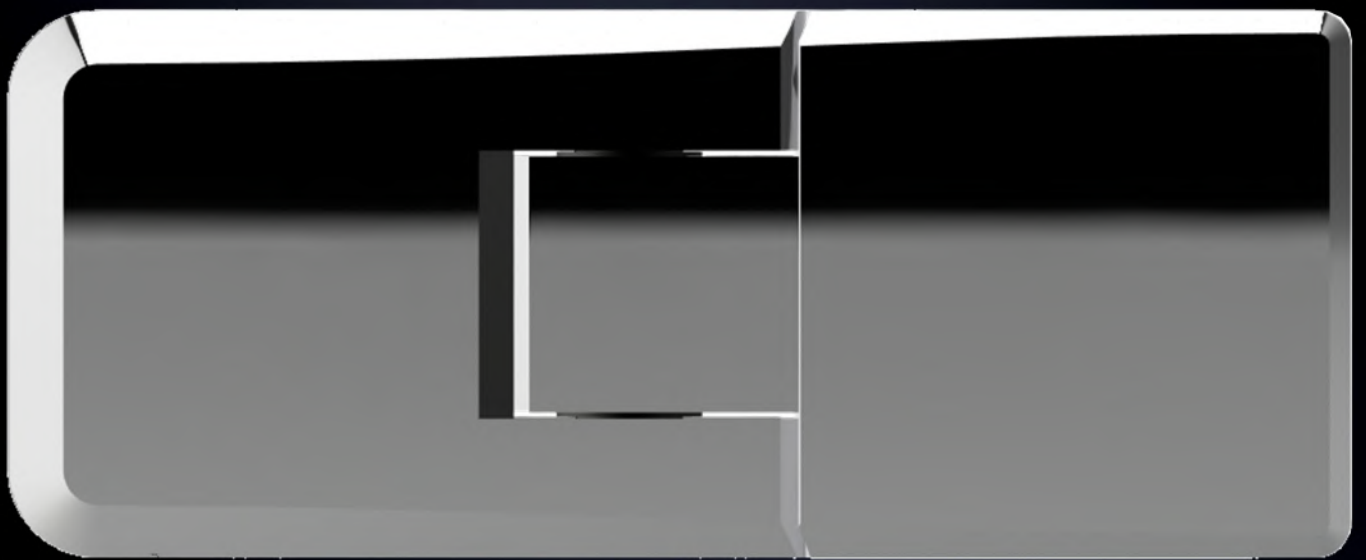

TECHNOGLASS®

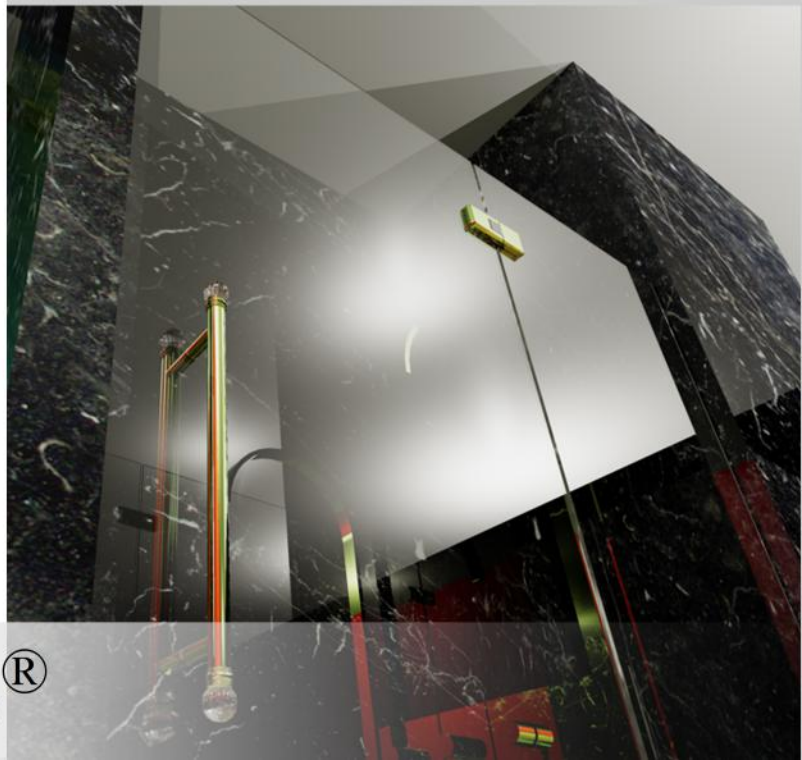
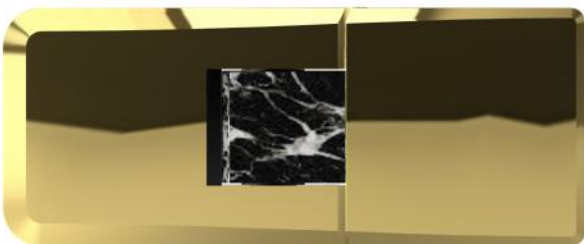
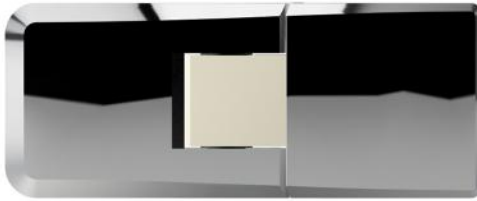
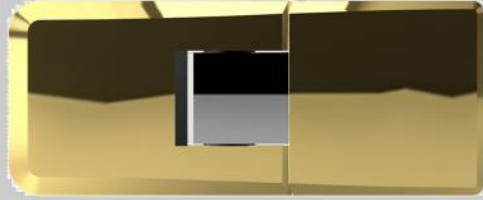
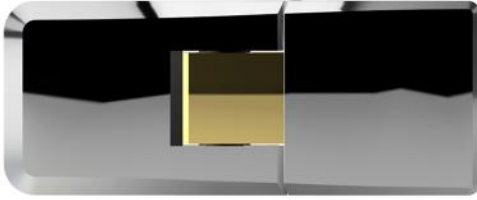
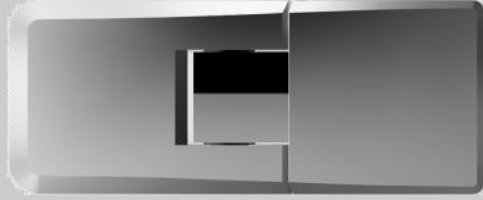
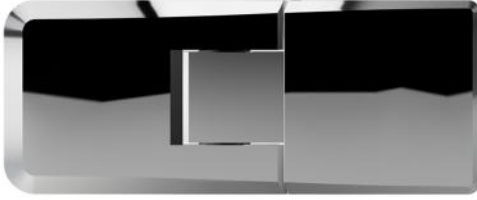
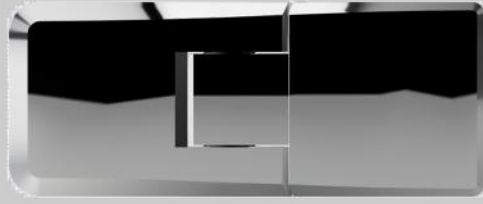
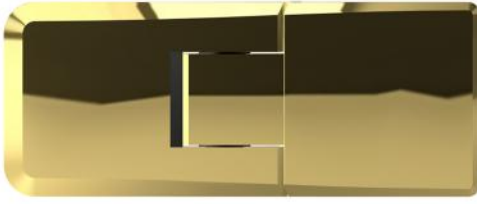

Cerniere per cabina doccia dall'innovativo e raffinato design, con diverse combinazioni di colori e finiture.

Fissaggio a filo-vetro interno per una pulizia più semplice delle superfici. Con sistema di sollevamento porta di 4 mm in apertura e regolazione del punto zero di chiusura. La tecnologia delle cerniere serie UP chiude delicatamente la porta dalla posizione aperta, semplicemente per gravità. Apertura interna ed esterna fino a 90°.

(Prodotto brevettato).

Scharniere für Duschkabinen mit einem innovativen und eleganten Design, mit verschiedenen Farbkombinationen und Oberflächen erhältlich. Mit flächenbündiger Montage für eine einfache Reinigung von Glasoberflächen, Hubsystem 4 mm in der Öffnungs- und einstellbarem Nullpunkt. UP-Serie Scharniere schließen sanft die Tür von der offenen Position, einfach durch die Schwerkraft und das Gewicht der Tür. 180° Öffnungswinkel, 90° nach innen und außen.

(Patentiertes Produkt).

Hinges for shower cubicles with an innovative and elegant design, available with different color combinations and surfaces. With flush mounting for easy cleaning of glass surfaces, door lifting system 4 mm in the opening and adjustable closure zero point. UP series hinges technology gently closes the door from the open position, simply by gravity.

180° opening angle, 90° inwards and outwards.

(Patented product).

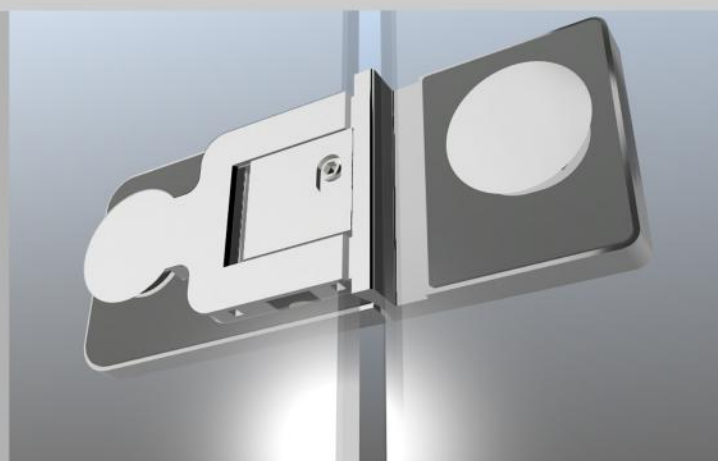
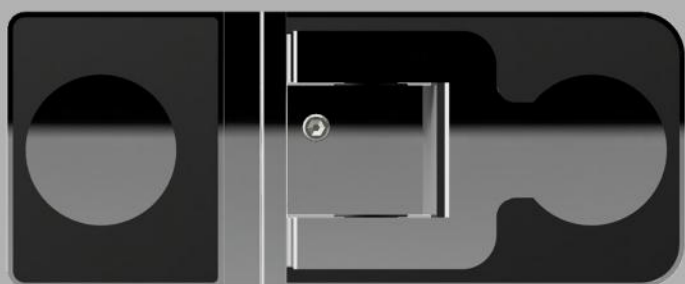
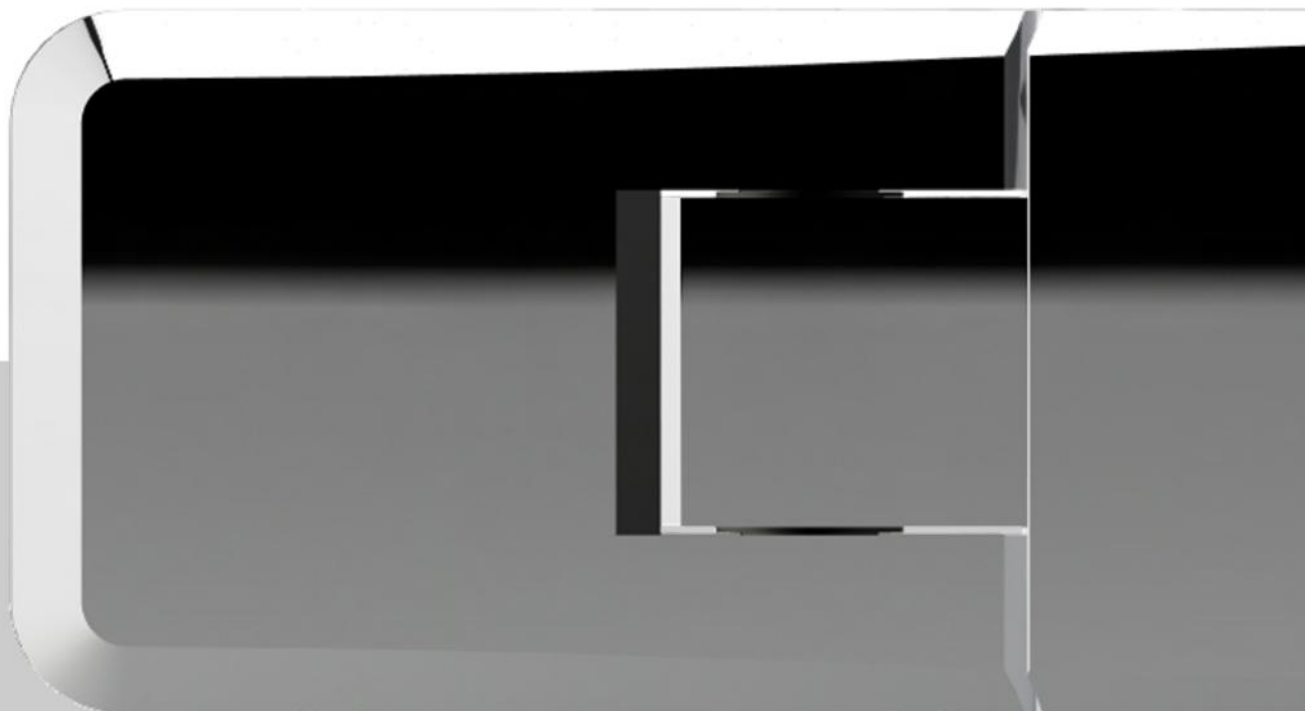



C0296
(DX-R)

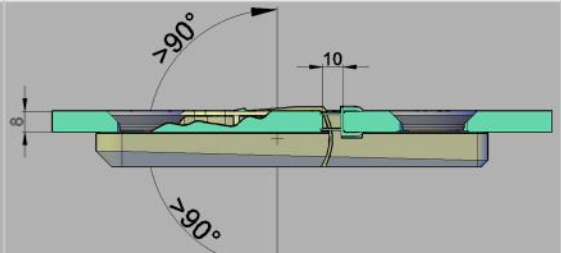
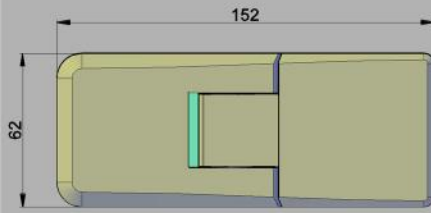

C0297
(SX-L)

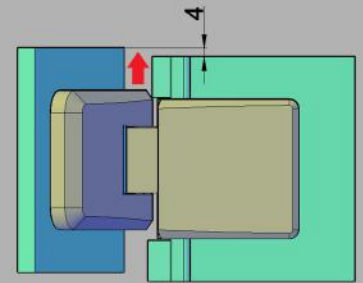
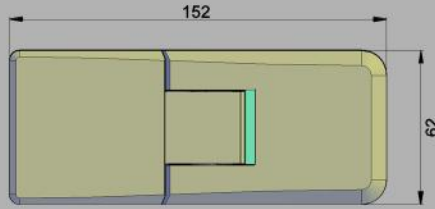

Preparazione lastre/Glasbearbeitung/Glass machining

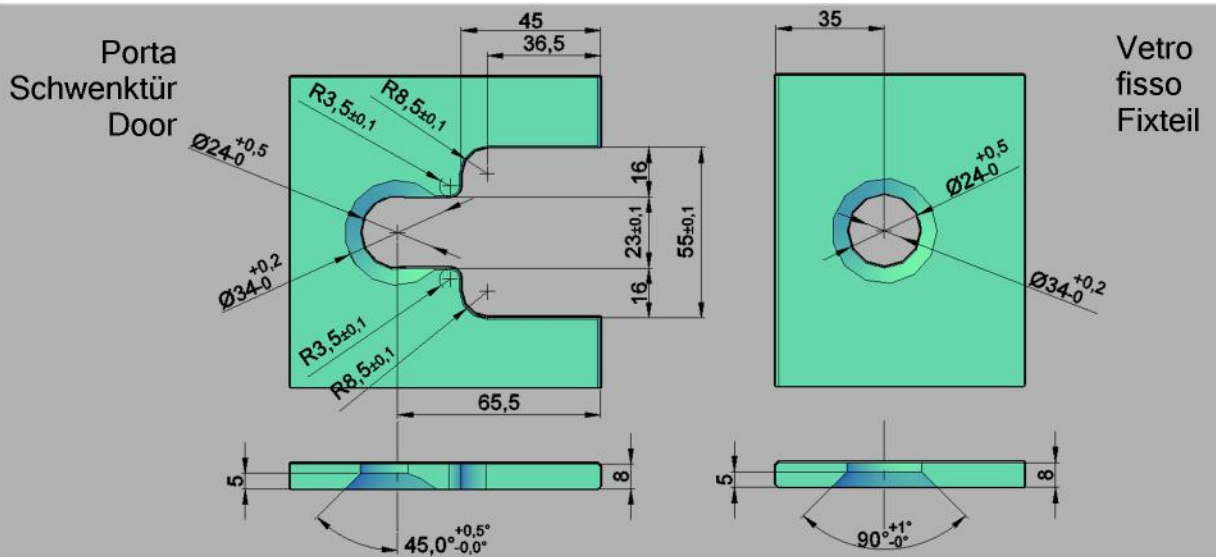

Spessore vetro 8mm. Peso porta max. 40 kg per coppia cerniere. Larghezza massima porta 800mm
 Glasdicke 8mm. Türgewicht max. 40 kg pro Paar Scharniere. Maximale Türbreite 800mm
 Glass thickness 8mm. Door weight max. 40 kg per hinge pair. Maximum door width 800mm





CRO

Cromo lucido
Poliertes Chrom
Bright chrome



CRS

Cromo satinato
Satin-Chrom
Satin chrome



CRP

Cromo perla
Perlchrom
Pearl chrome



INOX

Simil acciaio
Gebürsteter Stahl
Brushed steel



ORO

Oro lucido
Glänzend vergoldet
Shiny gold plated



BRO

Bronzo satinato
Satinbronze
Satin bronze



NER

Nero opaco
Matt schwarz
Matt black



BIA

Bianco opaco
Matt weiß
Matt white

Altre finiture su richiesta
Andere Ausführungen auf Anfrage
Other finishes on request

TECHNOGLASS®

Technoglass srl
Via A. Volta 53/a
25065 Lumezzane (Brescia) Italy
Tel. +39 030 8922522 / 8971735

e-mail: info@technoglass-cerniere.it
Web site: www.technoglass-hinges.com

